

Accuphase

Class A
INTEGRATED STEREO AMPLIFIER

E-530

- Triple parallel push-pull output stage with power MOS-FETs driven in pure class A delivers quality power: 30 watts per channel into 8 ohms
- Current feedback principle ensures superb phase characteristics in high frequency range
- Logic-controlled relays for shortest signal paths
- Tone controls
- Large toroidal power transformer provides ample reserves





The ultimate integrated amplifier operating in pure class A. Triple parallel output stage with power MOS-FET devices and strong power supply with toroidal transformer provide linear power progression: 120 W/ch (2 ohms), 60 W/ch (4 ohms), 30 W/ch (8 ohms). Current feedback topology in preamplifier and power amplifier sections assures superb sound.

The E-530 is the ultimate integrated amplifier. It represents the sophisticated knowledge gained by Accuphase over many years of designing superb components. Latest circuit topology is matched by top-quality parts. The Accuphase dedication to sound quality is in evidence everywhere. In the output stage, power MOS-FETs driven in pure class A provide a musical experience second to none. The sound is detailed, expressive, and exemplary. The E-530 is destined to become a new reference for an advanced generation of integrated amplifiers.

To assure low impedance and constant voltage speaker drive, the power amp section of the E-530 employs power MOS-FET devices arranged in a triple parallel configuration and operating in pure class A. The power supply features a large toroidal transformer and massive, high-quality filtering capacitors, supporting an output rating of 120 watts into 2 ohms, 60 watts into 4 ohms, or 30 watts into 8 ohms. This linear progression of power versus load impedance demonstrates the impressive capabilities of the E-530. Both the preamplifier section and power amplifier section use the highly renowned current feedback topology developed by Accuphase. The two sections can each be used in stand-alone mode. The E-530 is on a par with top-notch separate type amplifiers, both in terms of performance and sound quality.

To prevent any possibility of interference, the preamplifier is driven by its own dedicated power supply. Features such as tone controls and loudness compensation allow tailoring of the sound. Playback/record connections for two recorders as well as terminals for two sets of loudspeakers make the E-530 the ideal centerpiece of a quality audio system. An optional digital input board allows direct handling of the digital signal from a CD player or other digital component, for highest-grade

reproduction. Playback of analog records is also possible with an optional analog disc input board.

Triple parallel push-pull output stage with power MOS-FETs operating in pure class A. Linear power rating of 120 watts/2 ohms, 60 watts/4 ohms, or 30 watts/8 ohms.

The output stage (Figure 1) uses power MOS-FETs which have negative thermal characteristics. These are connected in a triple parallel configuration and driven in pure class A, ensuring linear power output down to extremely low load impedances. The parallel connection keeps output impedance low and minimizes inherent noise, and it also serves to distribute heat generated by the devices.

This design makes efficient use of the superb linearity of MOS-FET devices in the low power range, contributing to performance and sound quality. Figure 2 shows the output power/current characteristics for various load impedances. Output voltage remains largely

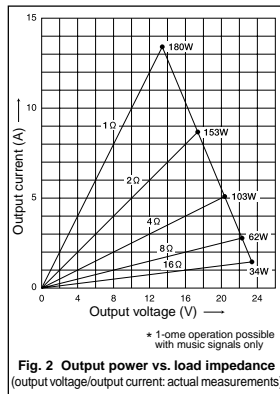
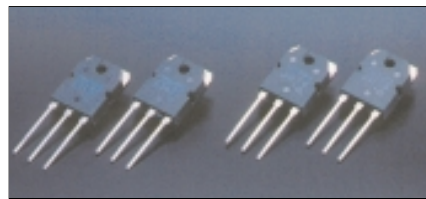

Fig. 2 Output power vs. load impedance (output voltage/output current: actual measurements)



Power MOS-FETs

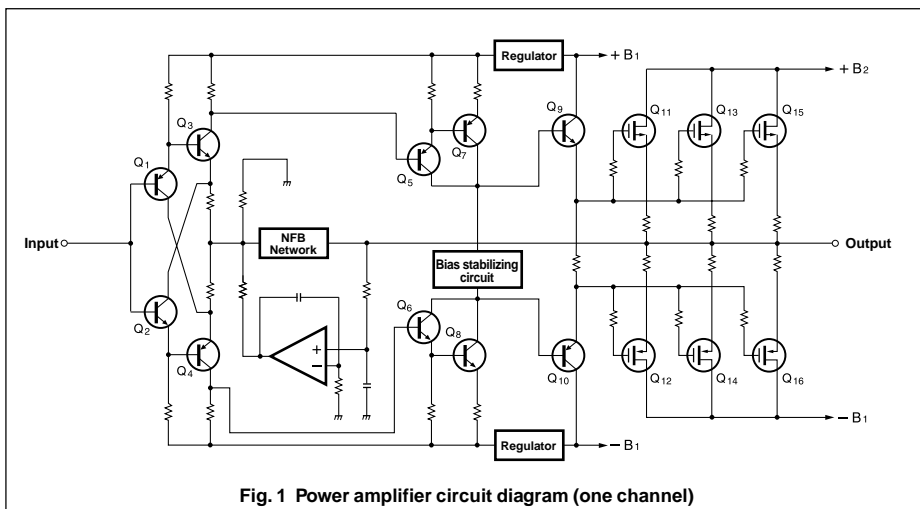

Fig. 1 Power amplifier circuit diagram (one channel)

constant even when load impedance changes, which means that the current increases linearly. The amplifier has ample reserves to handle musical signals with transient pulses, which is demonstrated by the clipping power rating from actual measurements: 180 watts into 1 ohm (music signals only), 153 watts into 2 ohms, 103 watts into 4 ohms, or 62 watts into 8 ohms.

Current feedback topology in power amplifier and preamplifier sections guarantees top-level performance

In the E-530, the signal current rather than the voltage is used for feedback. Figure 3 shows the operating principle of this circuit.

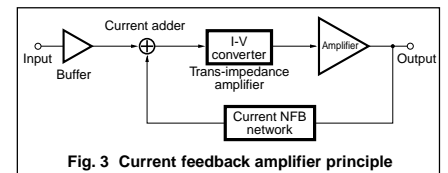

Fig. 3 Current feedback amplifier principle

Since the impedance at the current feedback point (current adder in Figure 3) is very low, there is almost no phase shift. Phase compensation can be kept to a minimum, resulting in excellent transient response and superb sonic transparency. Figure 4 shows frequency

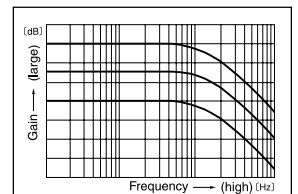

Fig. 4 Frequency response with current feedback (Response remains uniform even when gain changes)

response for different gain settings of the current feedback amplifier. The graphs demonstrate that response remains uniform over a wide range.

Discrete-type line amplifier for superior sonic purity

The line amplifier (Figure 5), which handles high-level signals from a CD player, tuner, or similar component, is entirely built from discrete parts. The circuit uses current feedback in a topology that results in a pure complementary push-pull configuration. The

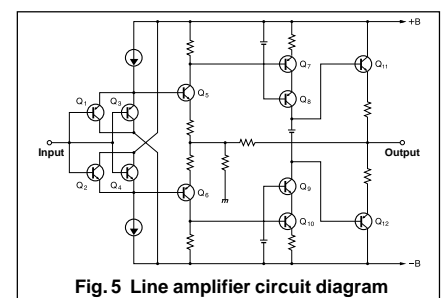
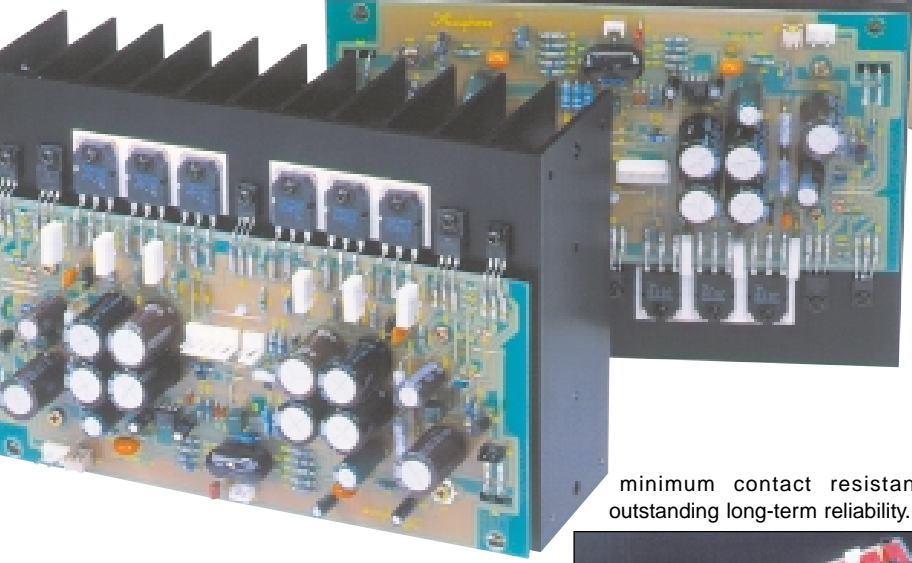

Fig. 5 Line amplifier circuit diagram



■ Power amplifier assembly with triple parallel power MOS-FETs and current feedback circuitry mounted to large heat sink



■ Supplied remote commander RC-29 Allows volume adjustment and source switching.

parallel arrangement of input devices helps to minimize noise.

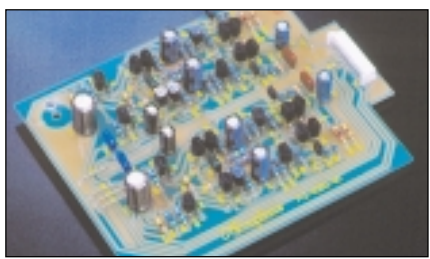

Line amplifier assembly

Highly reliable logic-controlled relays

Program source switching is performed by logic-controlled relays which are arranged so as to permit the shortest possible signal paths. The hermetically sealed relays are high-quality types developed specifically for demanding communication applications. The contacts are twin crossbar types plated with gold for

minimum contact resistance and outstanding long-term reliability.

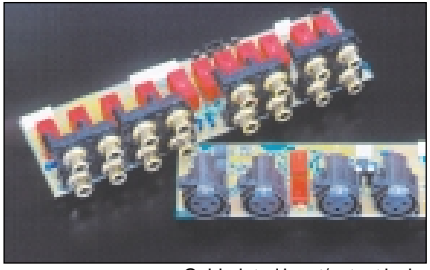

Gold-plated input/output jacks connected directly to relays

Tone controls use summing active filters for pure sound

The tone control circuitry in the E-530 was specially designed with summing active filters. Figure 6 illustrates the operation principle of this circuit. The flat signal is passed straight through, and only when an adjustment is required, the characteristics created at F1 and F2 are added to the signal, thereby producing the desired change. This design provides efficient control without degrading signal purity.

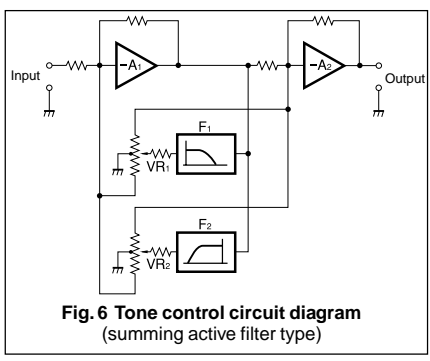

Large toroidal power transformer and high filtering capacity

The power supply section features a massive toroidal power transformer with a rating of 450 VA. The high-efficiency transformer is housed in a non-resonant aluminum enclosure. Two large electrolytic capacitors, each rated for 40,000 μF, assure ample reserves also for reproduction of the most demanding passages.



Other Features and Functions

- Option board slots allow easy function expansion
- Two speaker outputs
- Analog peak power meters
- High-quality volume control. Supplied remote commander for volume adjustment and source switching
- High carbon cast-iron insulator feet
- Dedicated headphone amplifier designed for high sound quality
- EXT PRE button and preamplifier output - Power amplifier input jacks allow separate use of both sections
- Loudness compensator for enhanced bass at low listening levels

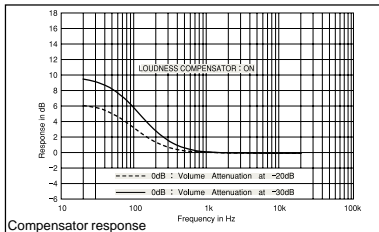

Option Boards

Three types of option boards are available for the E-530: Digital Input Board DAC-10, Analog Disc Input Board AD-10, and Line Input Board LINE-10. Insert the desired board in one of the rear-panel option board slots.

- It is also possible to use two identical boards in both slots.
- The Analog Disc Input Board AD-9 and the Line Input Board LINE-9 can also be used.
- The DAC-10 cannot be used in the models E-407, E-406V, E-306V, E-211, and C-265.

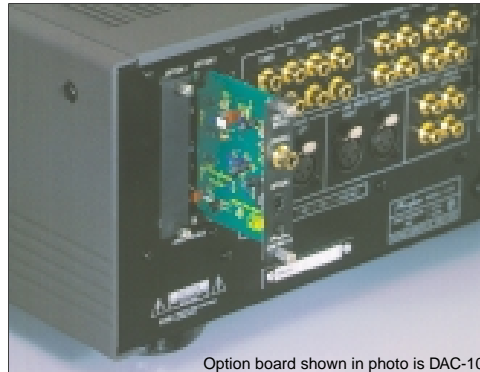

Digital Input Board DAC-10

This board features an MDS (Multiple Delta Sigma) D/A converter and has inputs for coaxial and optical fiber connections.

It can accept the digital output signal from components such as a CD player, MD recorder, DAT recorder, etc. (sampling frequency range 32 - 96 kHz, 24 bits).

Analog Disc Input Board AD-10

This board contains a high-performance, high-gain phono equalizer.

- Internal DIP switches control MM/MC operation, MC input impedance, and subsonic filter on/off.

MM	Gain	: 36 dB
	Input impedance	: 47 kilohms
MC	Gain	: 62 dB
	Input impedance	: 10/30/100 ohms (selectable)

Line Input Board LINE-10

This option board provides an additional set of conventional unbalanced line inputs which can be used to connect a CD player, tuner, or other component with analog output.

Front panel

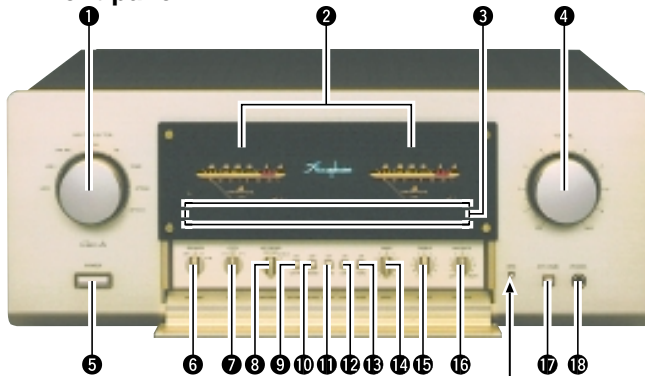

Rear panel

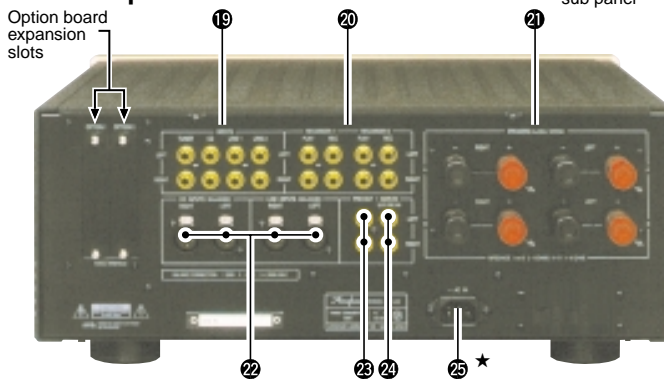

- | | |
|---|--|
| <ul style="list-style-type: none"> ① INPUT SELECTOR
LINE2 LINE1 LINE-BAL CD-BAL
CD TUNER OPTION1 OPTION2 ② Power Meters
(Decibel Output indication (dB/%)) ③ Function LED indicators ④ VOLUME Control ⑤ POWER Switch ⑥ SPEAKER Selector OFF A B A+B ⑦ COPY Selector 1→2 OFF 2→1 ⑧ RECORDER Selector
REC OFF SOURCE 1 2 ⑨ EXT PRE (Preamplifier/Power Amplifier Separator) ON/OFF Button ⑩ METER Display On/Off Button | <ul style="list-style-type: none"> ⑪ STEREO/MONO Button ⑫ COMP (Compensator) ON/OFF Button ⑬ TONE Controls ON/OFF Button ⑭ BASS Control ⑮ TREBLE Control ⑯ BALANCE Control ⑰ Attenuator Switch ⑱ PHONES Jack ⑲ Line inputs ⑳ Recorder Input/Output Jacks ㉑ SPEAKERS Terminals (A, B) ㉒ CD/LINE INPUTS (BALANCED) ㉓ PRE OUT Preamplifier Output Jacks ㉔ MAIN IN Power Amplifier Input Jacks ㉕ AC Power Supply Connector* |
|---|--|

Remarks

- ★ This product is available in versions for 120/230 V AC. Make sure that the voltage shown on the rear panel matches the AC line voltage in your area.
- ★ The shape of the AC inlet and plug of the supplied power cord depends on the voltage rating and destination country.

- Supplied accessories:
 - AC power cord
 - Remote commander RC-29

GUARANTEED SPECIFICATIONS

[Guaranteed specifications are measured according to EIA standard RS-490.]

- **Continuous Average Output Power (both channels driven, 20 - 20,000 Hz)**
150 watts per channel into 1 ohm (*)
120 watts per channel into 2 ohms
60 watts per channel into 4 ohms
40 watts per channel into 6 ohms
30 watts per channel into 8 ohms
Note: 1-ohm ratings marked (*) are for music signals only.
- **Total Harmonic Distortion (both channels driven, 20 - 20,000 Hz)**
0.05%, with 2-ohm load
0.02%, with 4 to 16-ohm load
- **Intermodulation Distortion** 0.01%
- **Frequency Response** HIGH LEVEL INPUT / MAIN INPUT
20 to 20,000 Hz 0 -0.2 dB (At continuous average rated output)
2 to 150,000 Hz 0 -3.0 dB (At 1 watt output)
- **Damping Factor** 120 (with 8-ohm load, 50 Hz)
- **Input Sensitivity, Input Impedance**

Input	Sensitivity		Input impedance
	For rated output	For 1 W output (EIA)	
HIGH LEVEL INPUT	61.7 mV	11.3 mV	20 kΩ
BALANCED INPUT	61.7 mV	11.3 mV	40 kΩ
MAIN INPUT	0.617 V	113 mV	20 kΩ

- **Output Load Impedance** PRE OUTPUT: 0.617 V 50 ohms
(At continuous average rated output)
- **Gain** HIGH LEVEL INPUT → PRE OUTPUT: 20 dB
MAIN IN → OUTPUT: 28 dB
- **Tone Controls** Turnover frequency and adjustment range
BASS: 300 Hz ±10 dB (50 Hz)
TREBLE: 3 kHz ±10 dB (20 kHz)
- **Loudness Compensation** +6 dB (100 Hz) (Volume control setting -30 dB)
- **Attenuator** -20 dB
- **Signal-to-Noise Ratio**

Input	Input shorted, IHF-A weighting	S/N ratio (EIA)
	S/N ratio at rated input	
HIGH LEVEL INPUT	106 dB	80 dB
BALANCED INPUT	92 dB	80 dB
MAIN INPUT	92 dB	80 dB

- **Power Level Meters** Logarithmic compression, peak reading meters with a dB scale, Output indication (dB / %)
- **Load Impedance** 2 - 16 ohms
- **Stereo Headphones** Suitable impedance: 8 - 100 ohms
- **Power Requirements** 120V/230V (Voltage as indicated on rear panel) AC, 50/60 Hz
- **Power Consumption** 180 watts idle
280 watts in accordance with IEC-65
- **Maximum Dimensions** Width 475 mm (18-11/16")
Height 196 mm (5-7/8")
Depth 422 mm (16-5/8")
- **Weight** 25.0 kg (55.1 lbs) net
30.0 kg (66.1 lbs) in shipping carton